

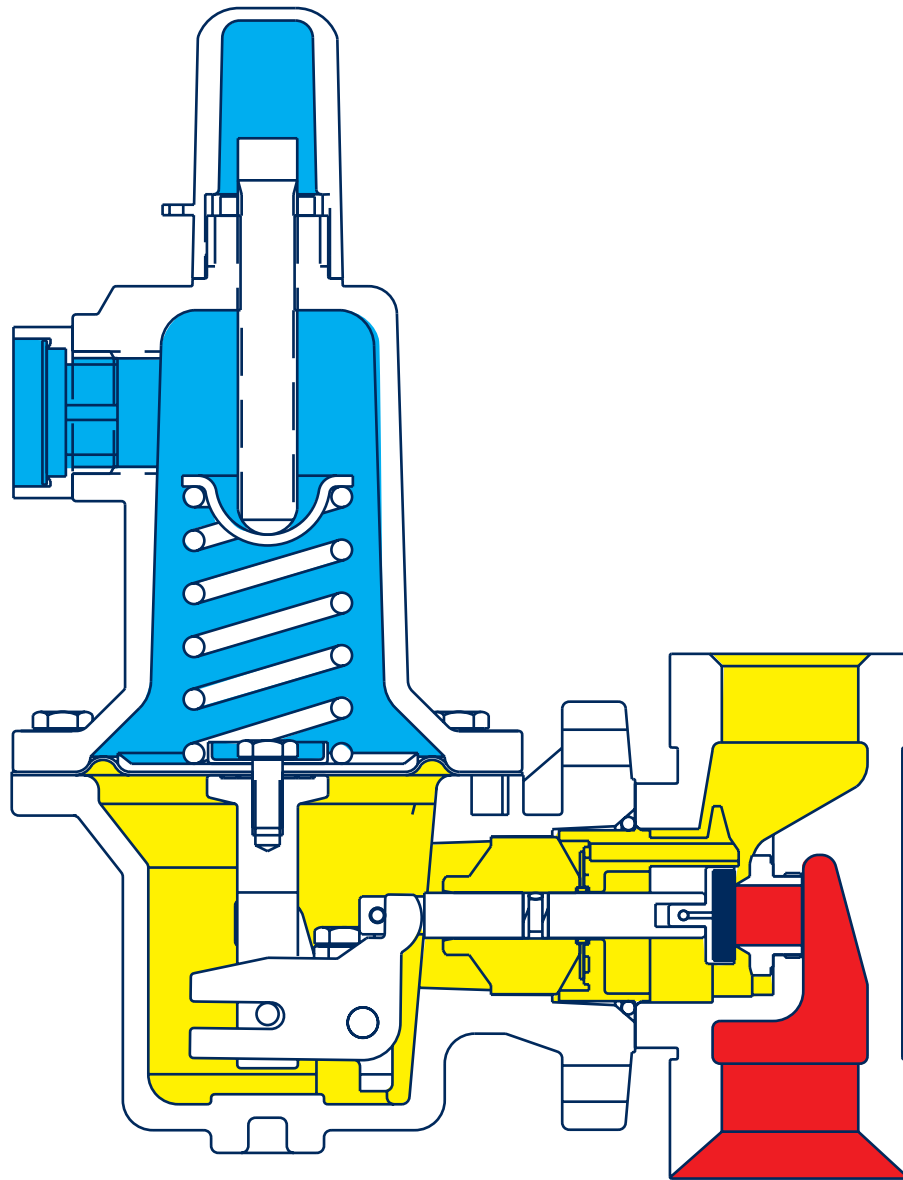

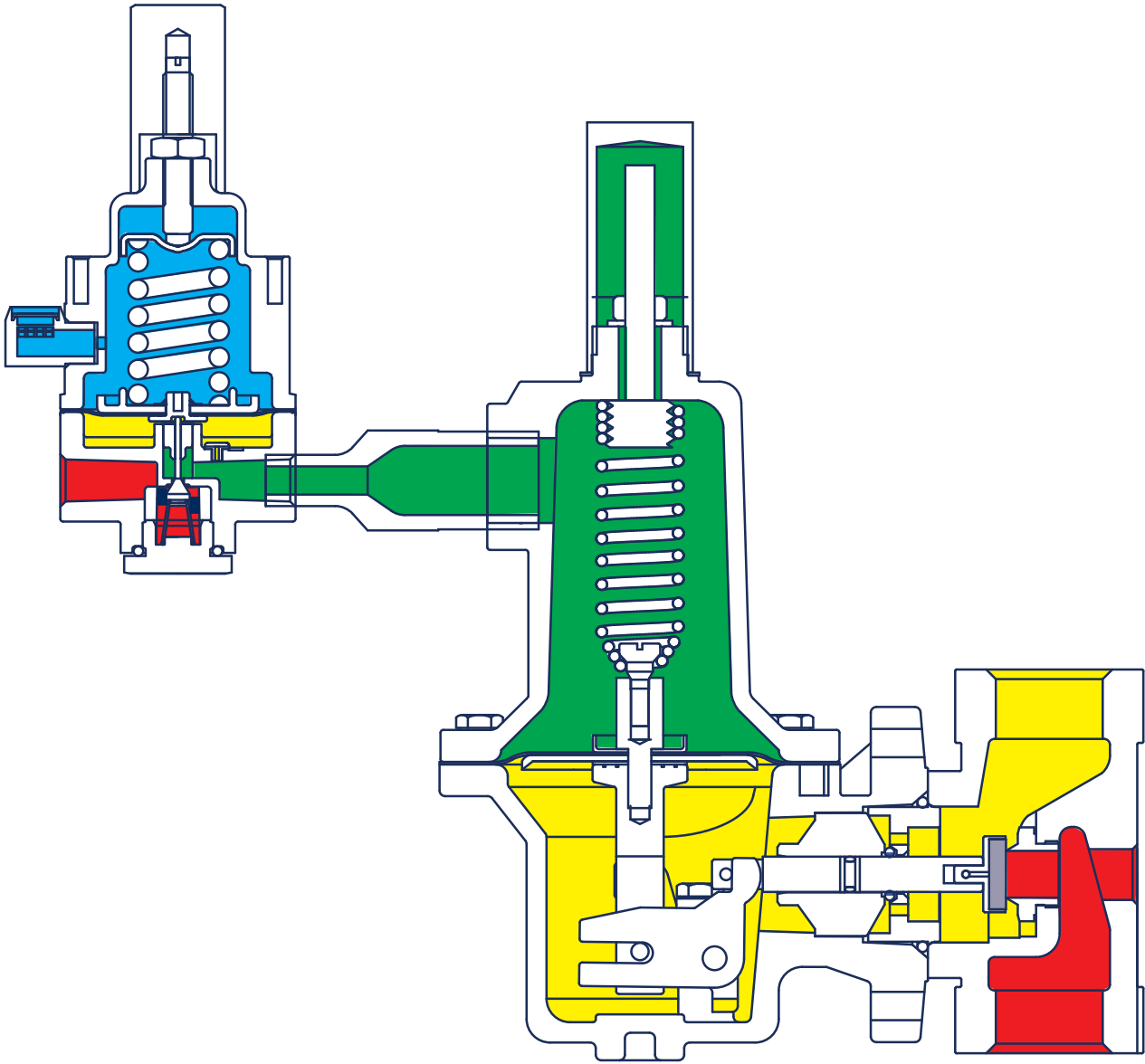

P627



- Inlet Pressure
- Outlet Pressure
- Atmospheric Pressure

F627



-  Inlet Pressure
-  Outlet Pressure
-  Atmospheric Pressure
-  Loading Pressure

P630

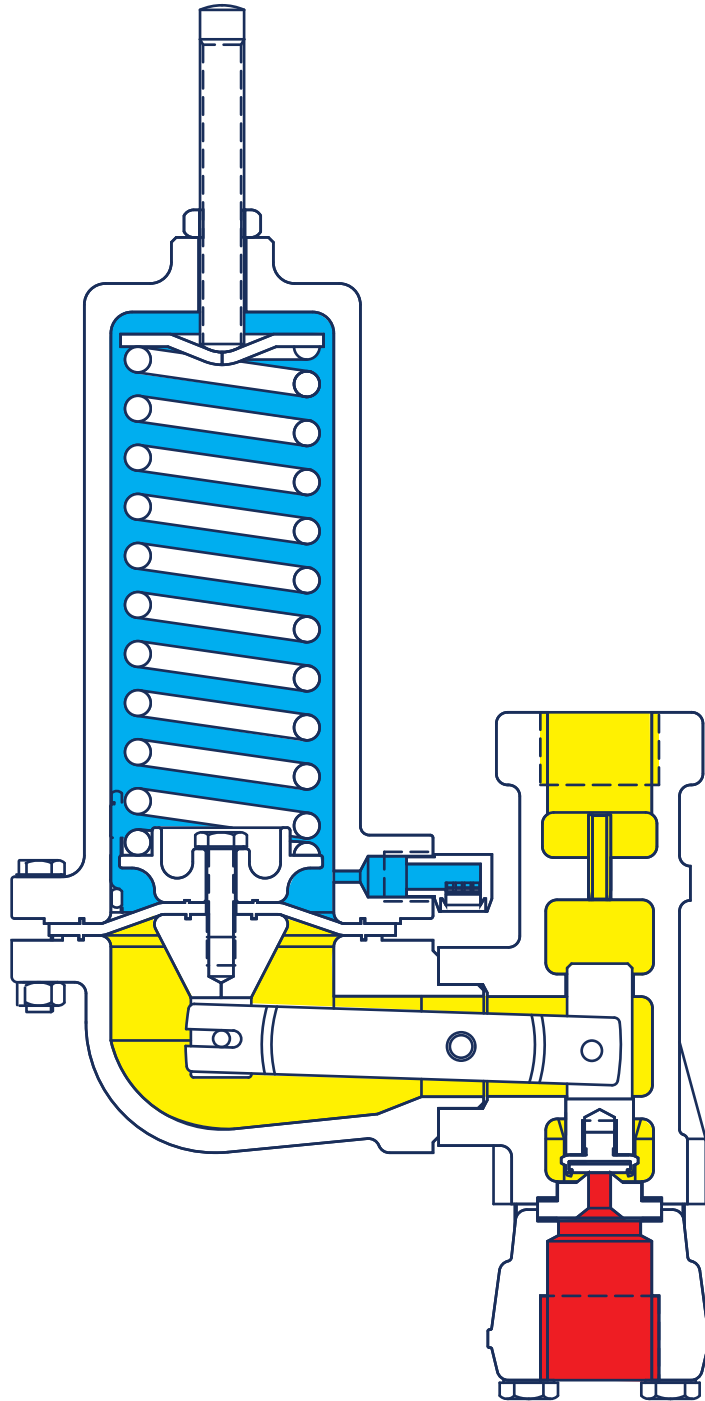

-  Inlet Pressure
-  Outlet Pressure
-  Atmospheric Pressure

P630R

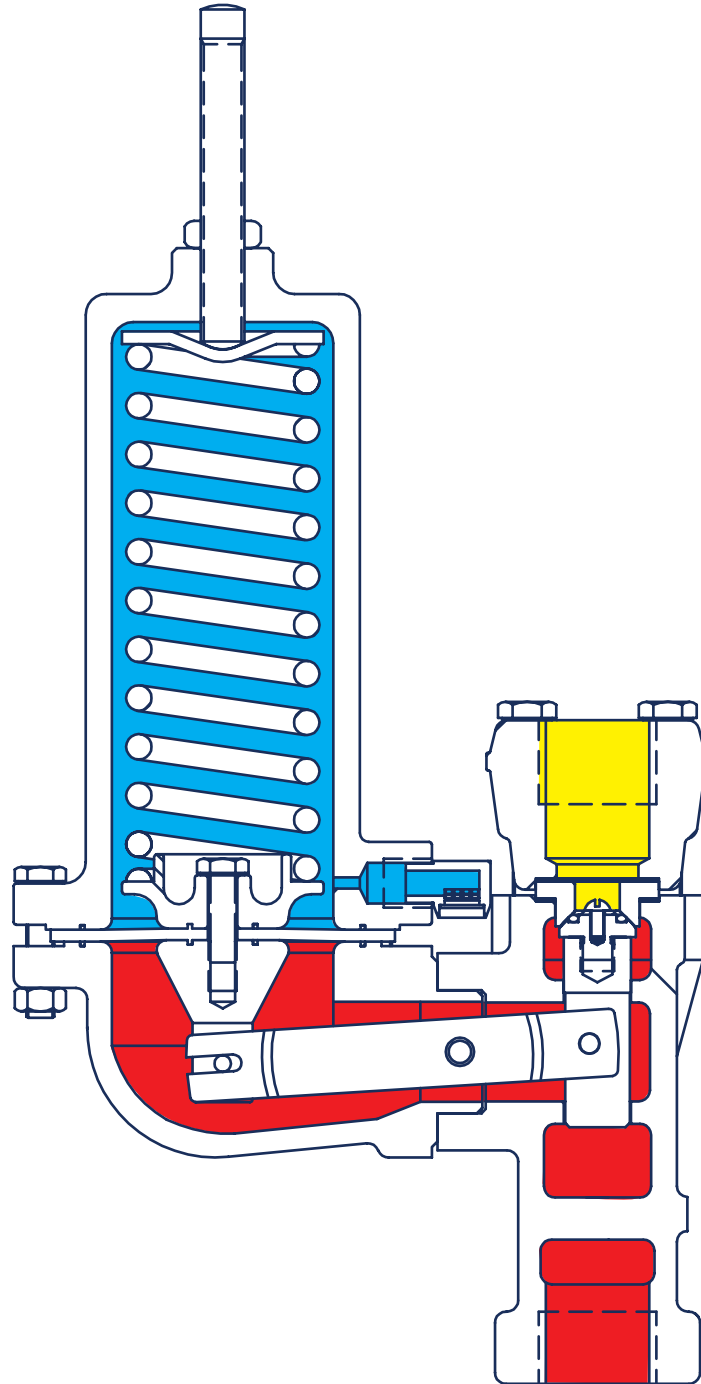

-  Inlet Pressure
-  Exhaust Pressure
-  Atmospheric Pressure

F289 1"

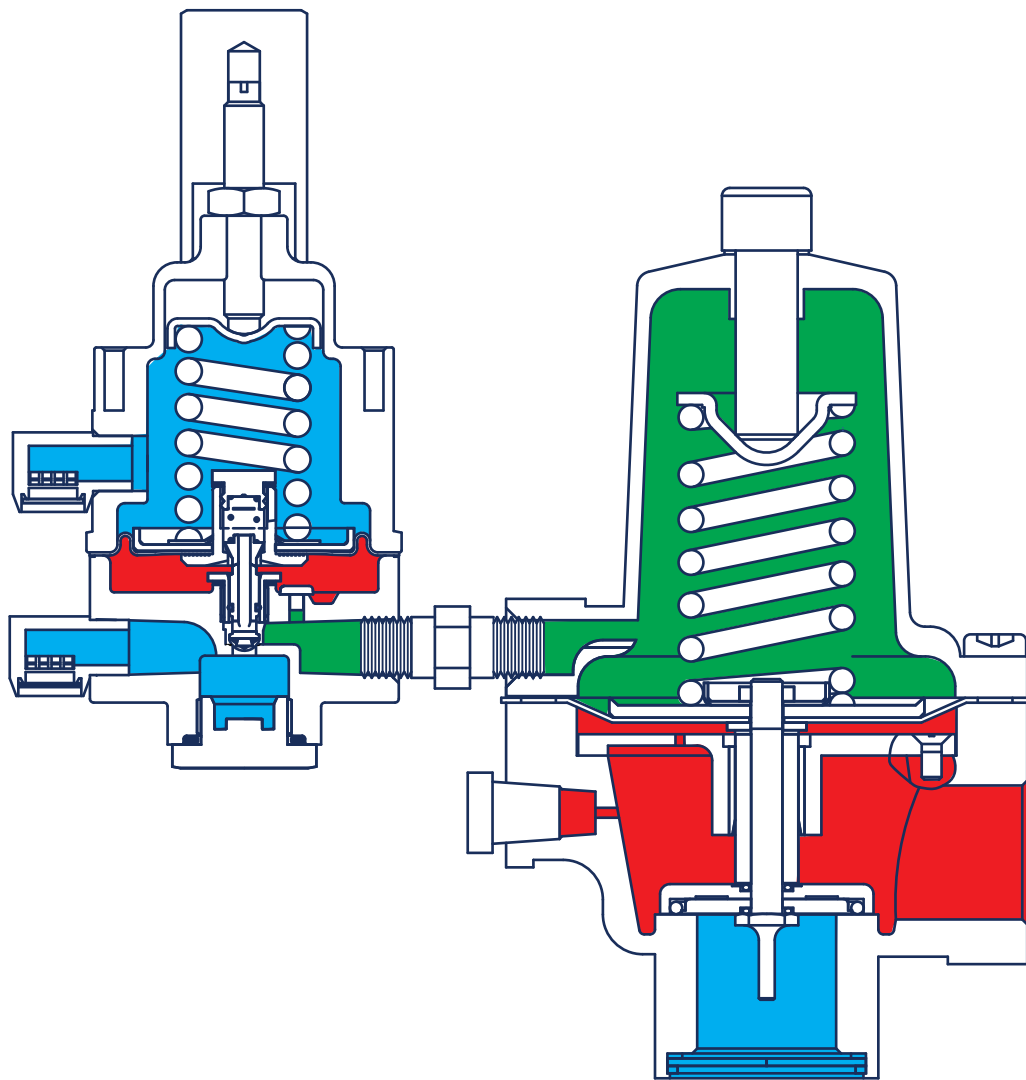

- Inlet Pressure
- Atmospheric Pressure
- Loading Pressure

P289 2"

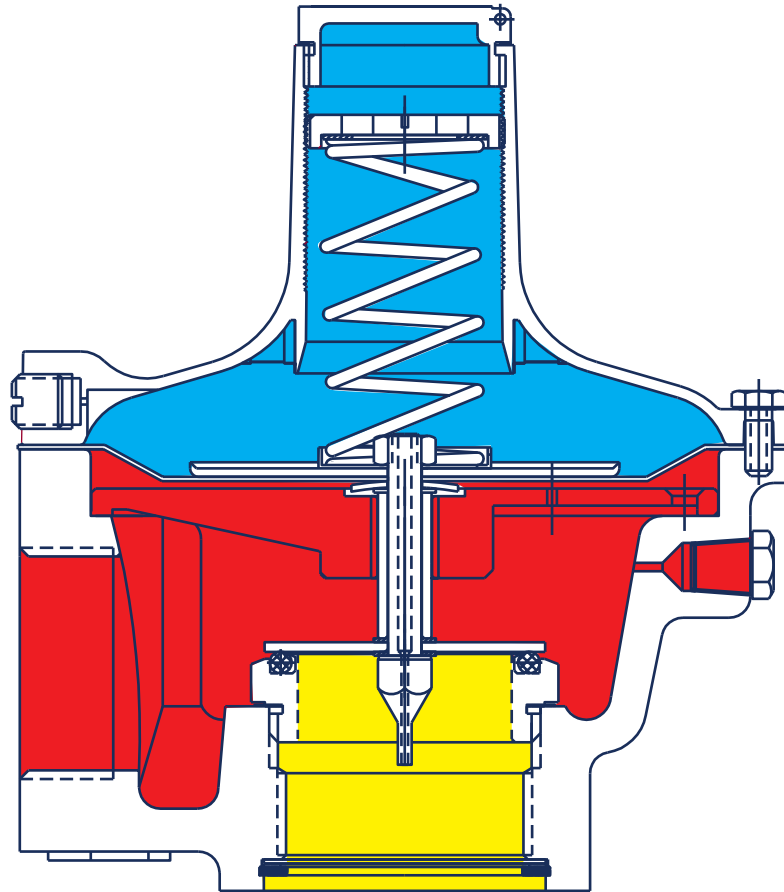

-  Inlet Pressure
-  Exhaust Pressure
-  Atmospheric Pressure

F289 1"

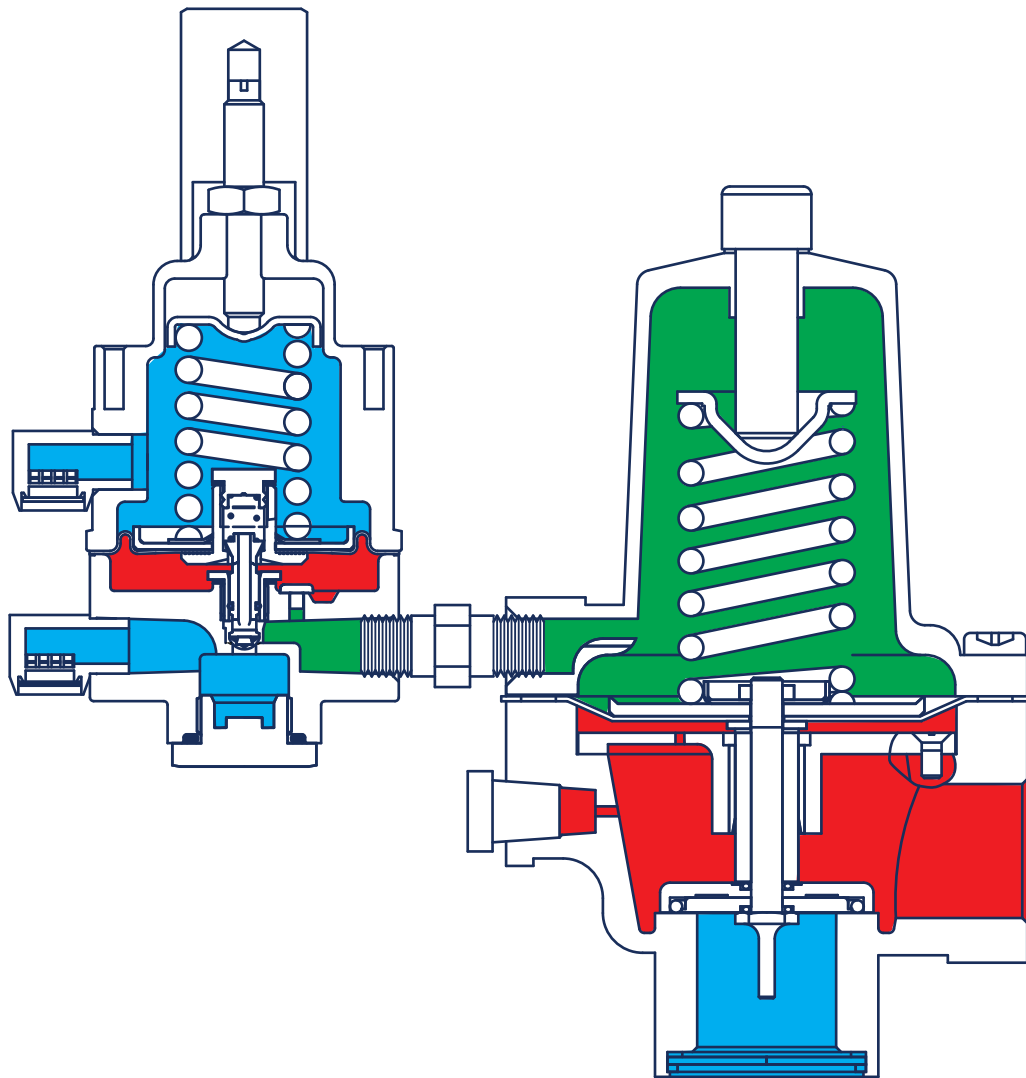

- Inlet Pressure
- Atmospheric Pressure
- Loading Pressure

F289 2"

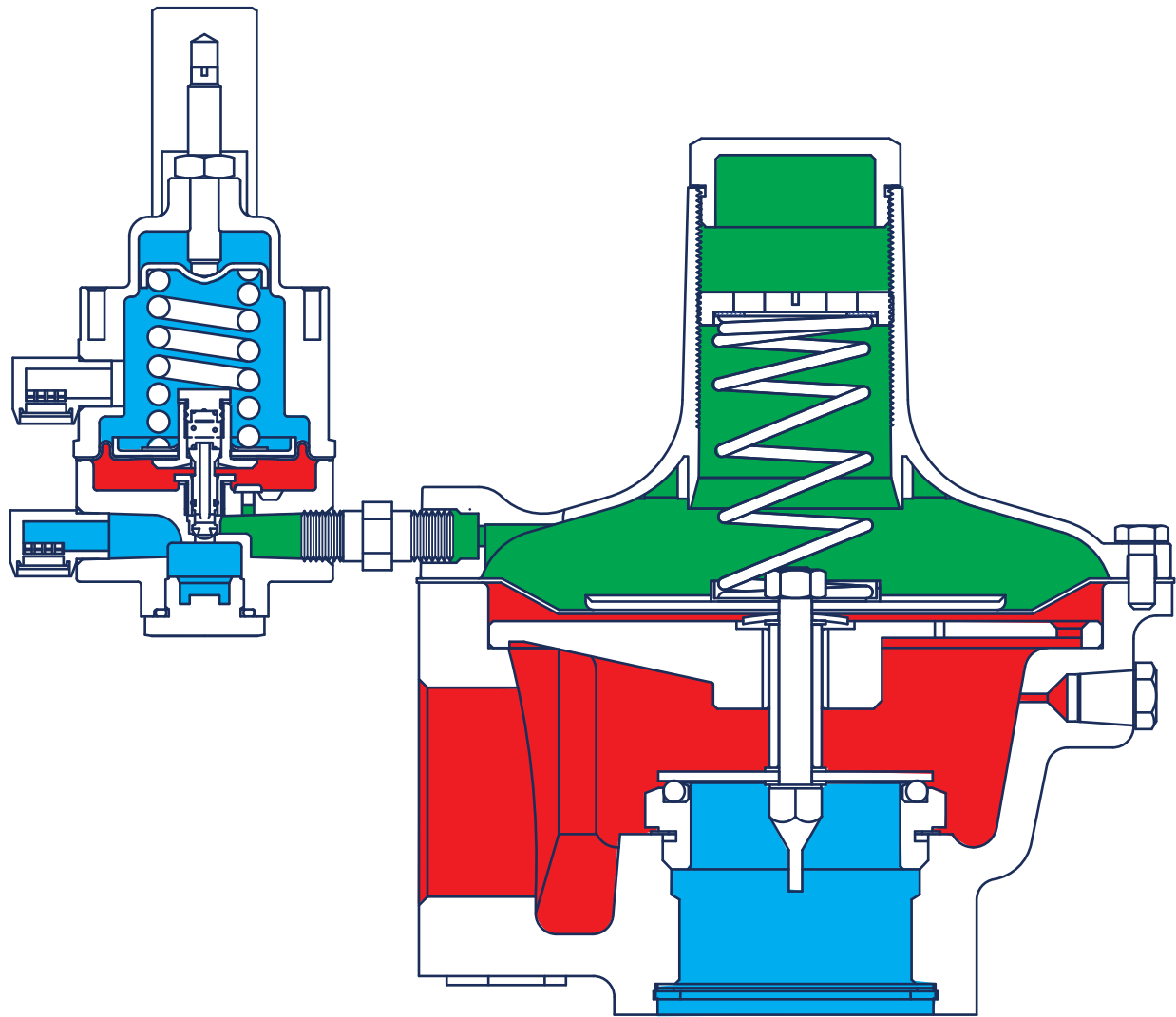

-  Inlet Pressure
-  Atmospheric Pressure
-  Loading Pressure

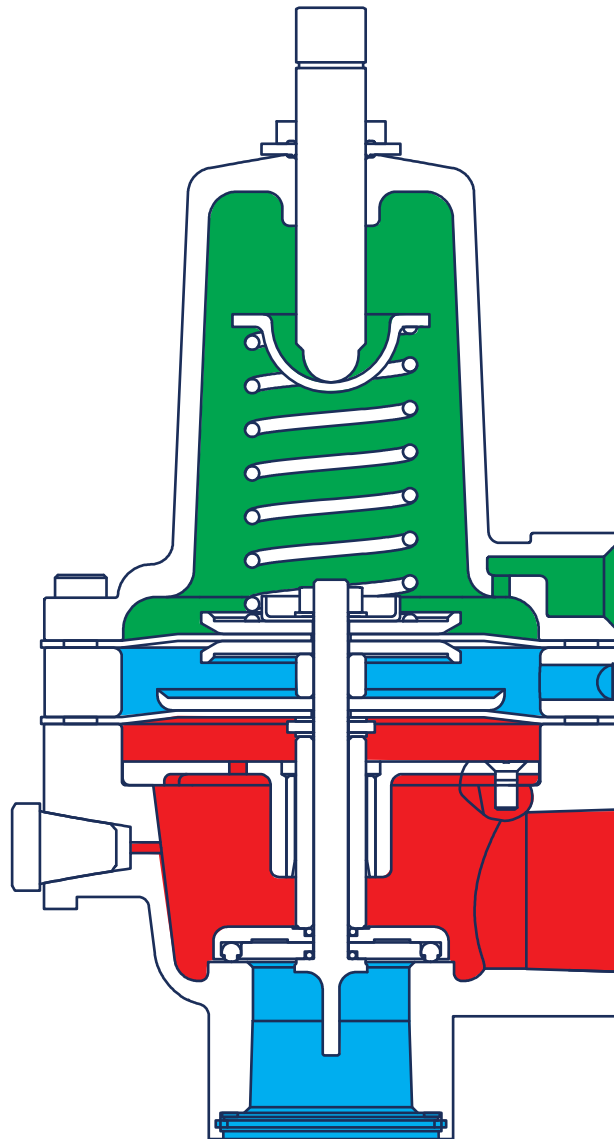

P289RC

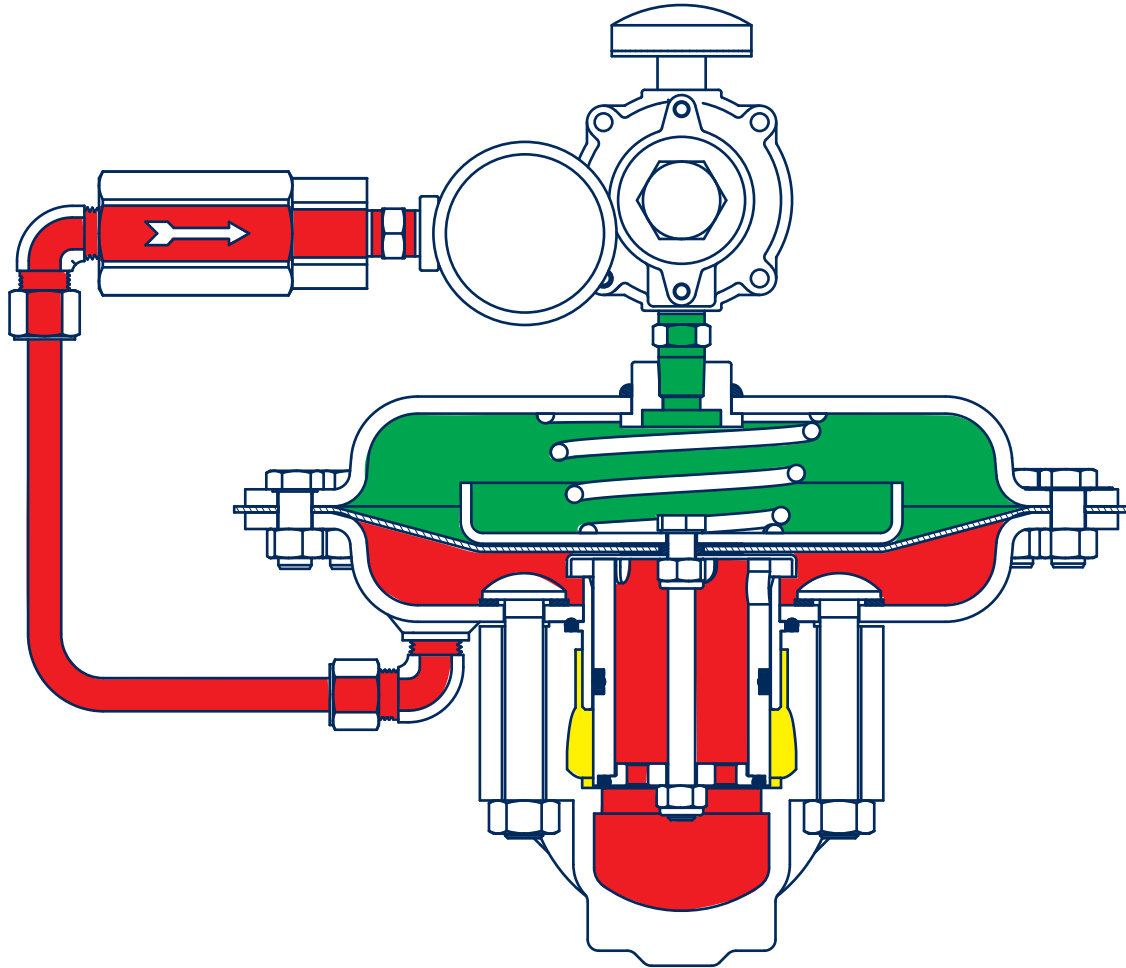

-  Inlet Pressure
-  Atmospheric Pressure
-  Loading Pressure

P1808



-  Inlet Pressure
-  Outlet Pressure
-  Loading Pressure

P203

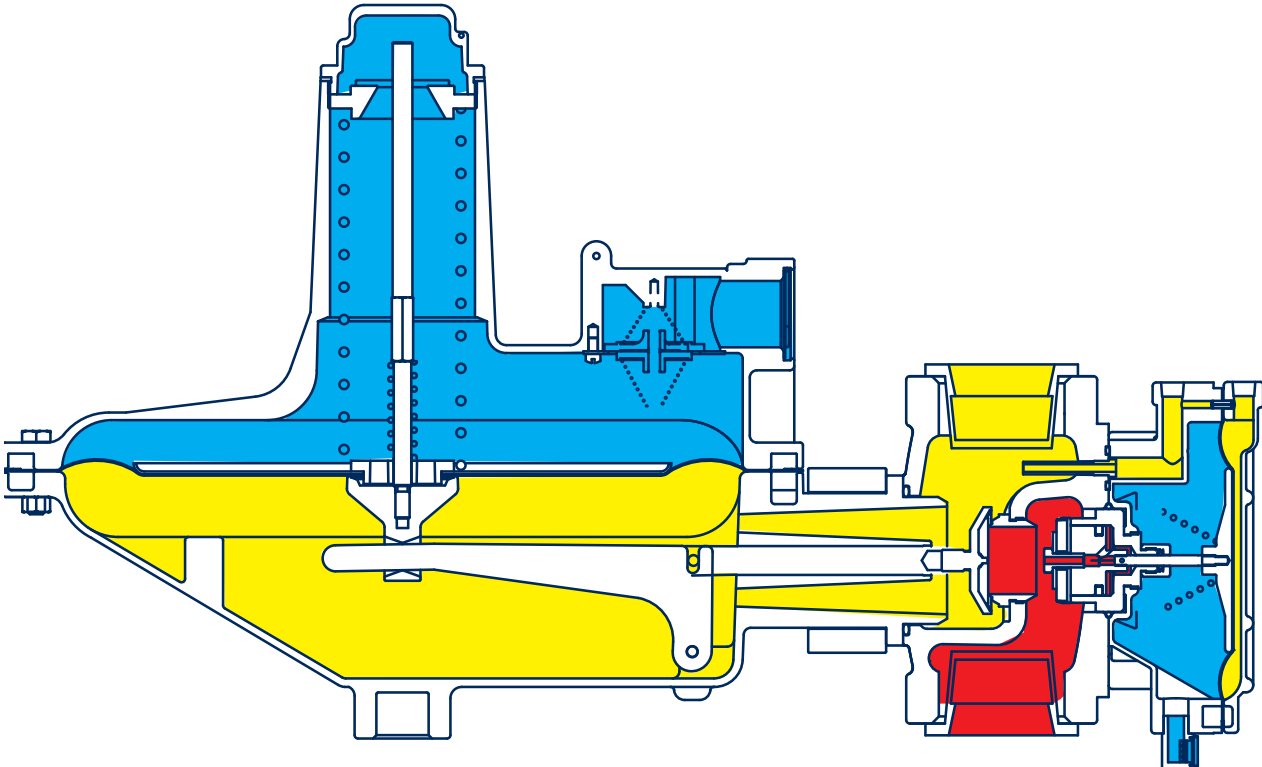



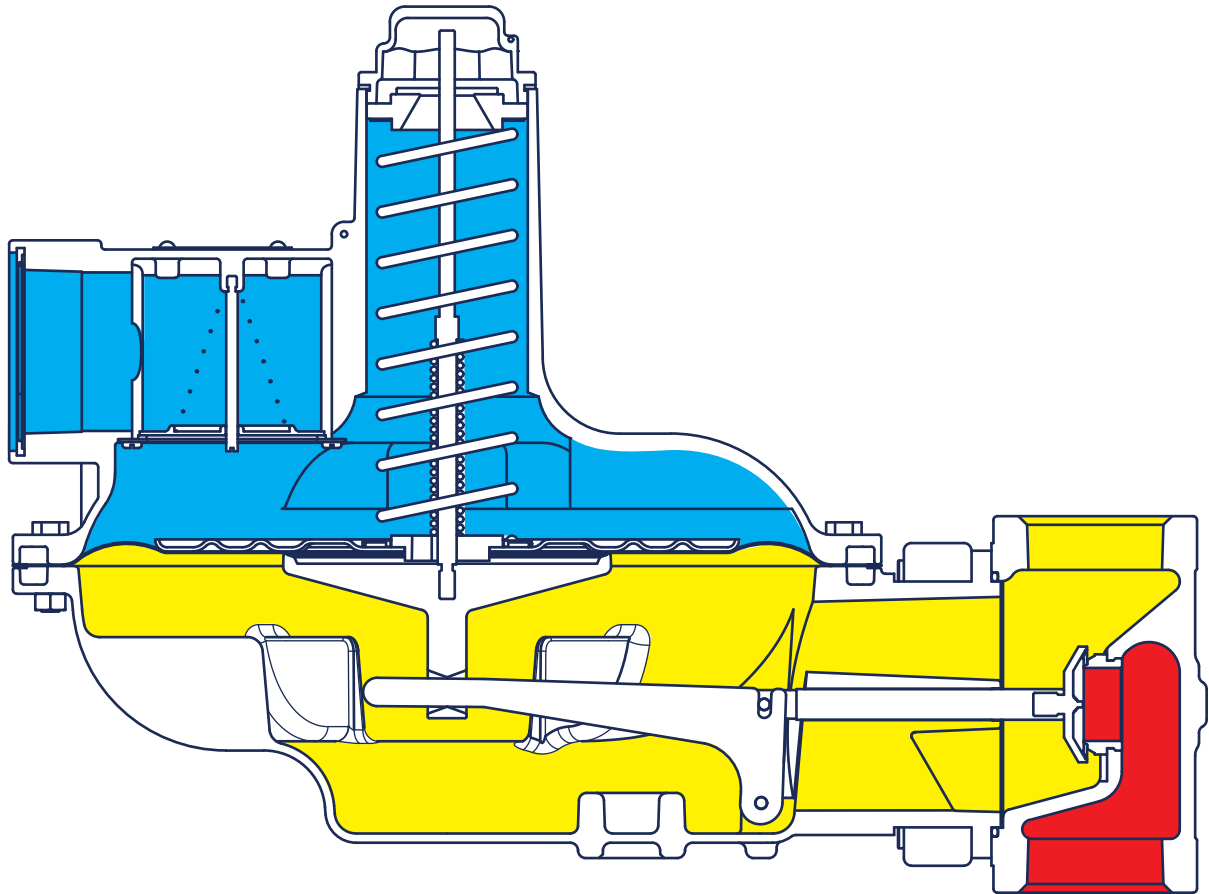

-  Inlet Pressure
-  Outlet Pressure
-  Atmospheric Pressure

P212

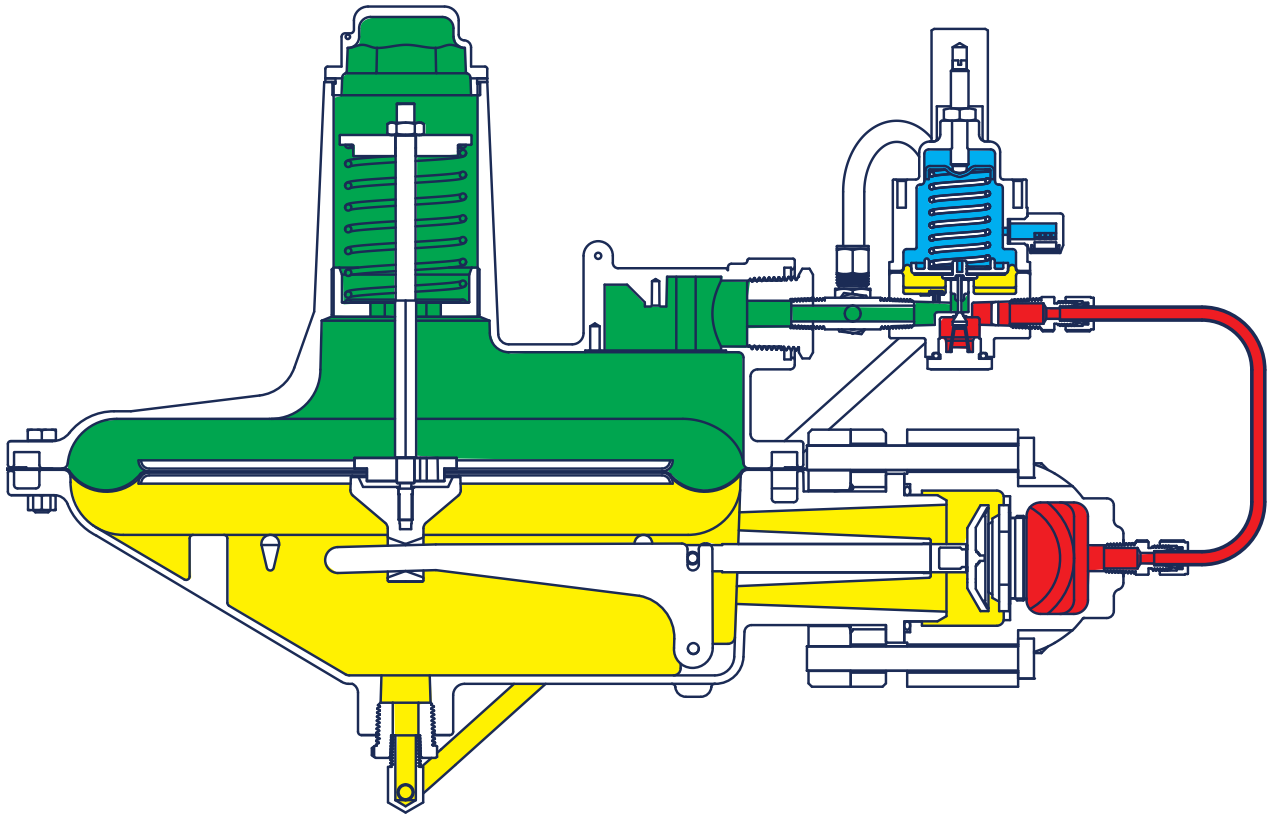
-  Inlet Pressure
-  Outlet Pressure
-  Atmospheric Pressure

F200



-  Inlet Pressure
-  Outlet Pressure
-  Atmospheric Pressure
-  Loading Pressure

P300

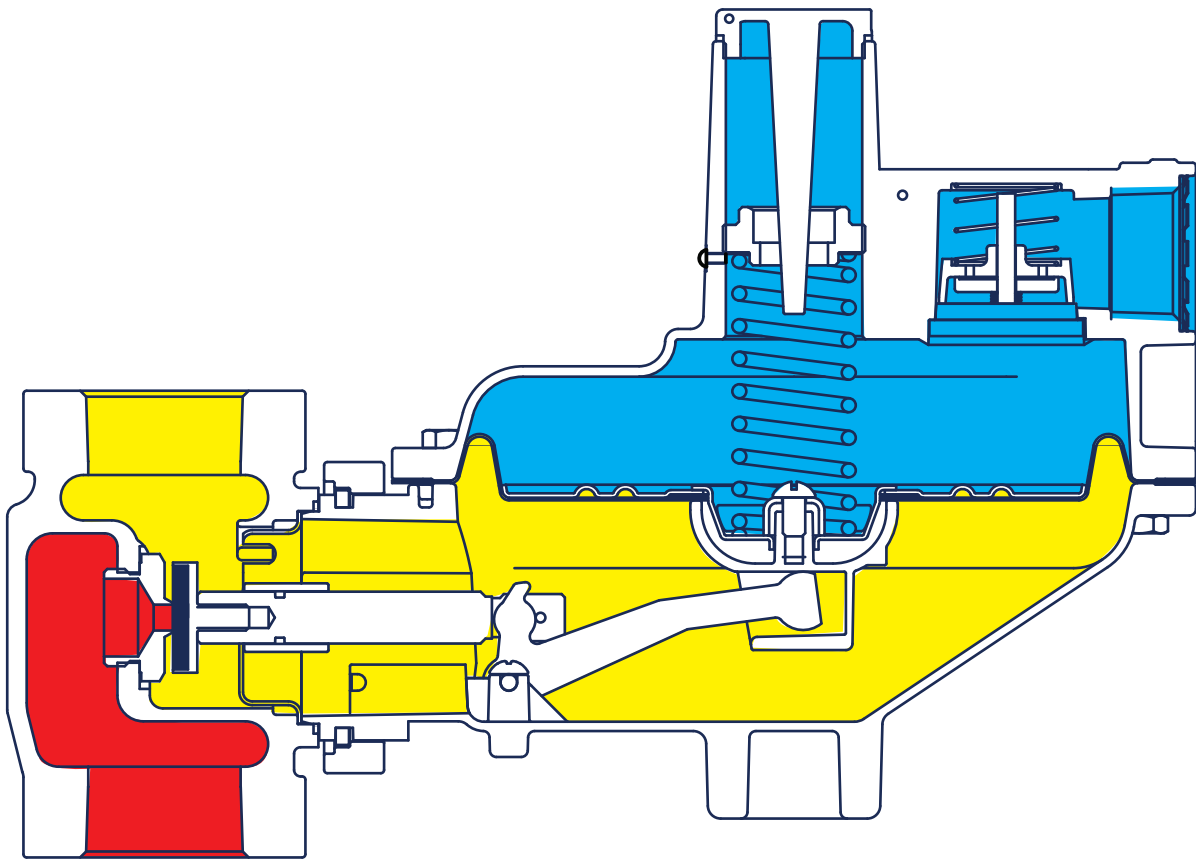

-  Inlet Pressure
-  Outlet Pressure
-  Atmospheric Pressure

P600

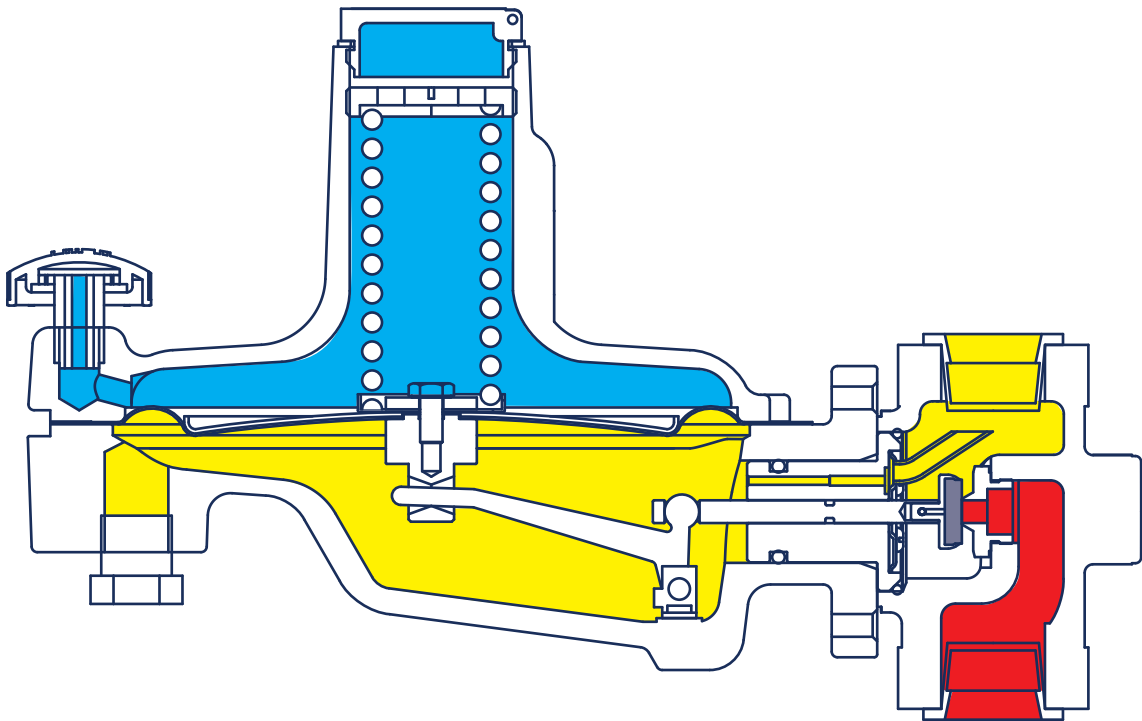

-  Inlet Pressure
-  Outlet Pressure
-  Atmospheric Pressure

P143

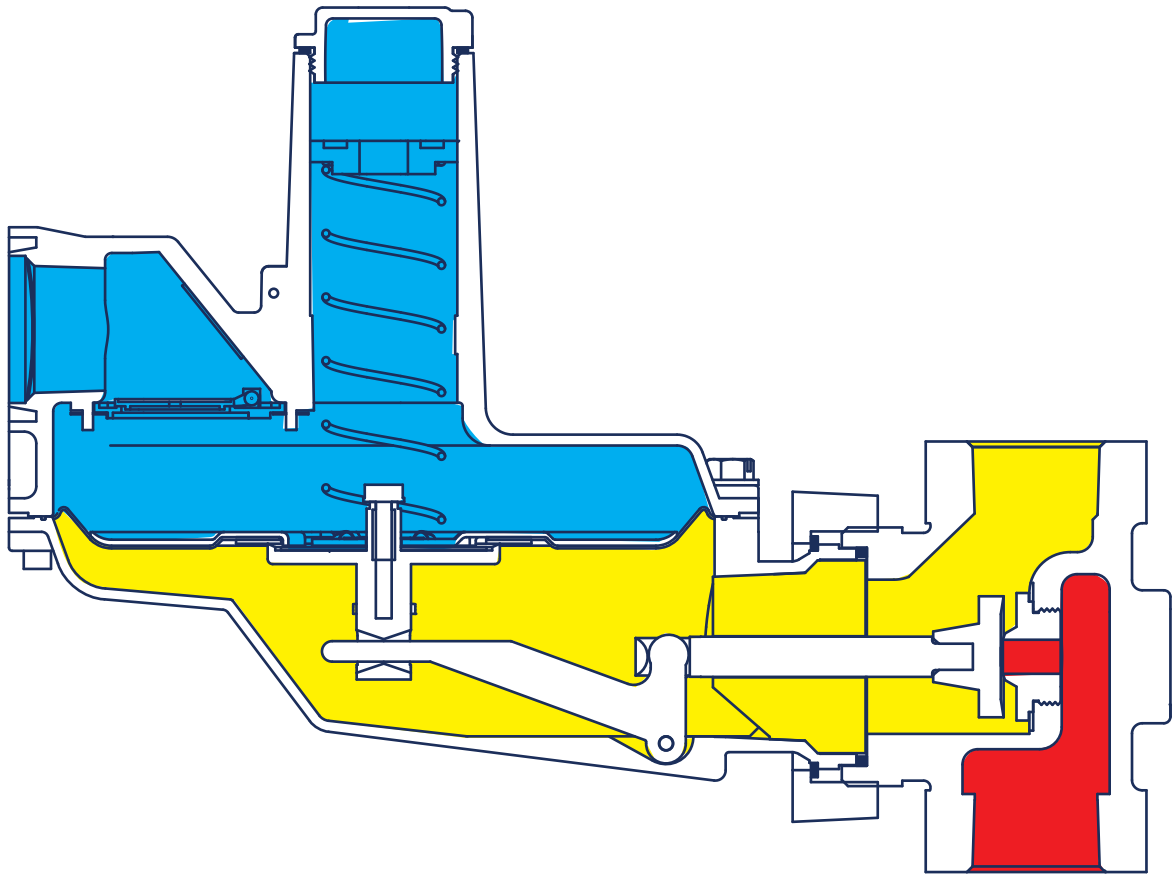

-  Inlet Pressure
-  Outlet Pressure
-  Atmospheric Pressure

P140

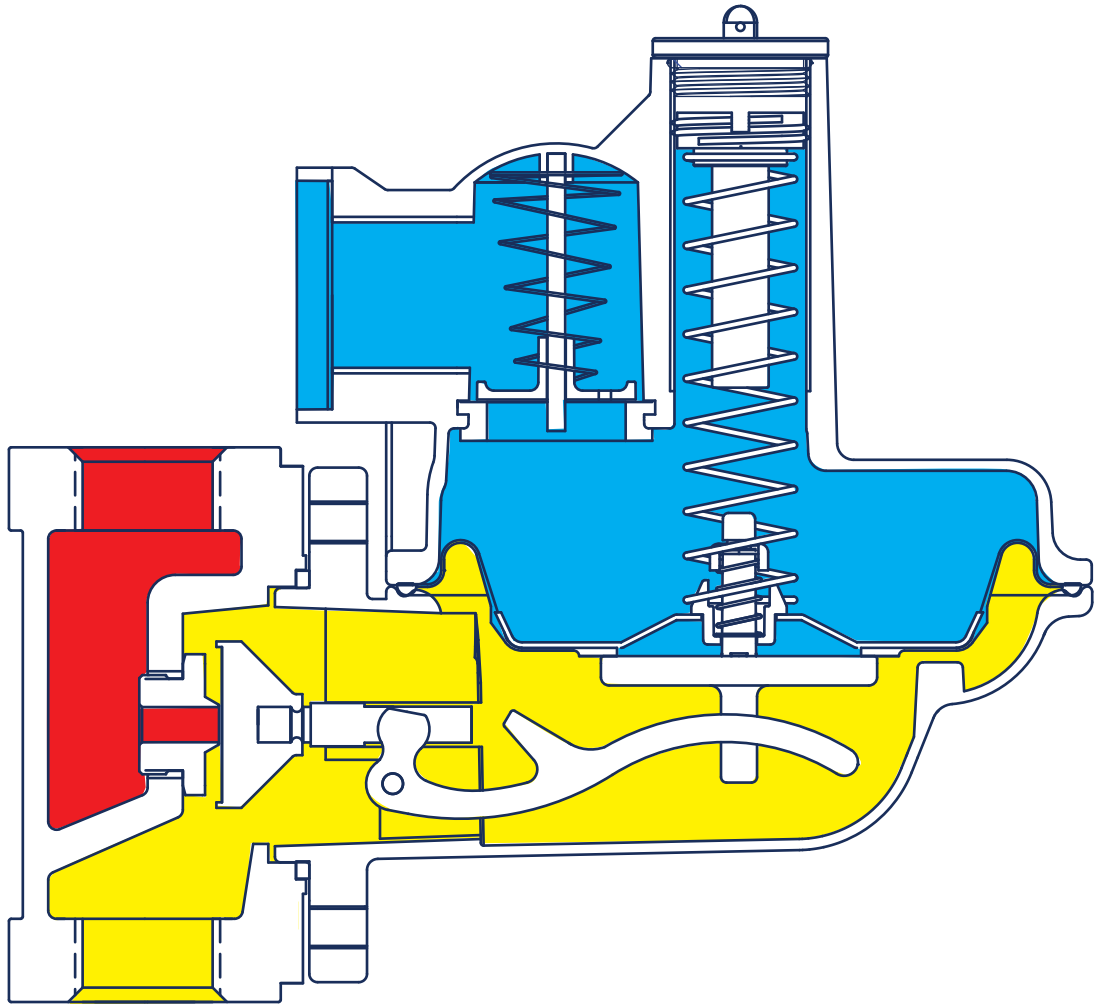

-  Inlet Pressure
-  Outlet Pressure
-  Atmospheric Pressure



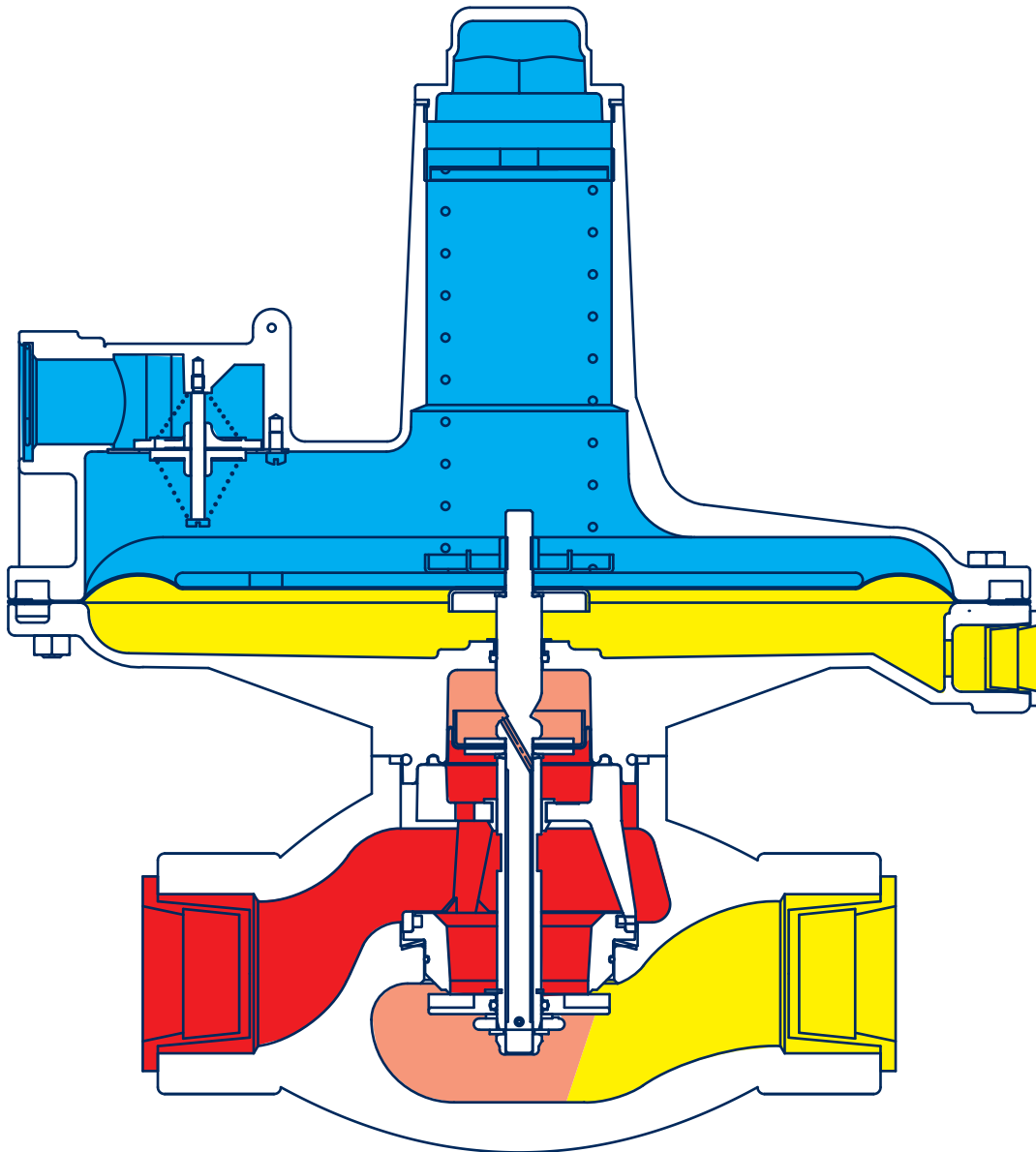

P133 H

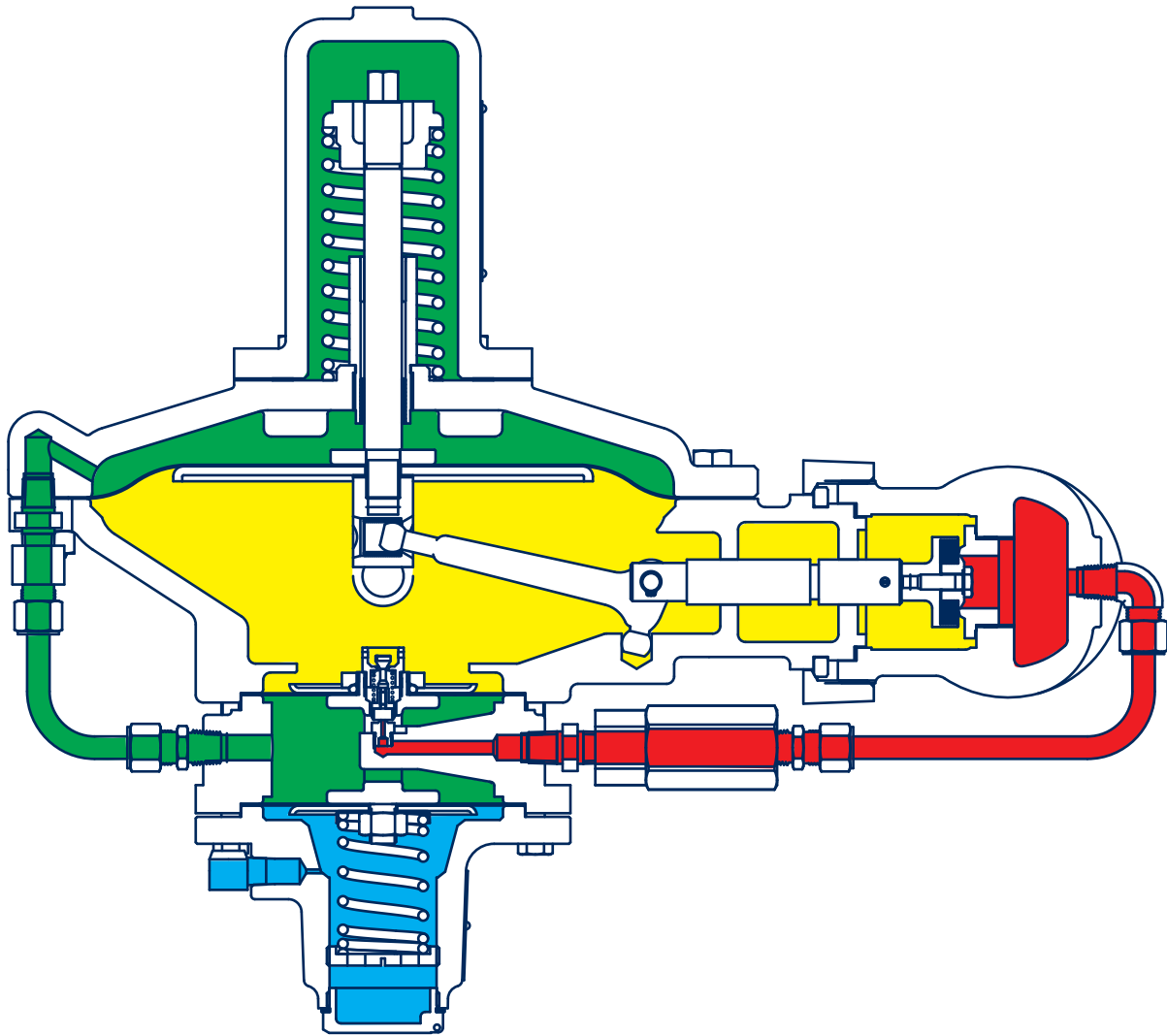

- Inlet Pressure
- Boost Pressure
- Outlet Pressure
- Atmospheric Pressure

P99



-  Inlet Pressure
-  Outlet Pressure
-  Atmospheric Pressure
-  Loading Pressure

P95H 1/2 NPT

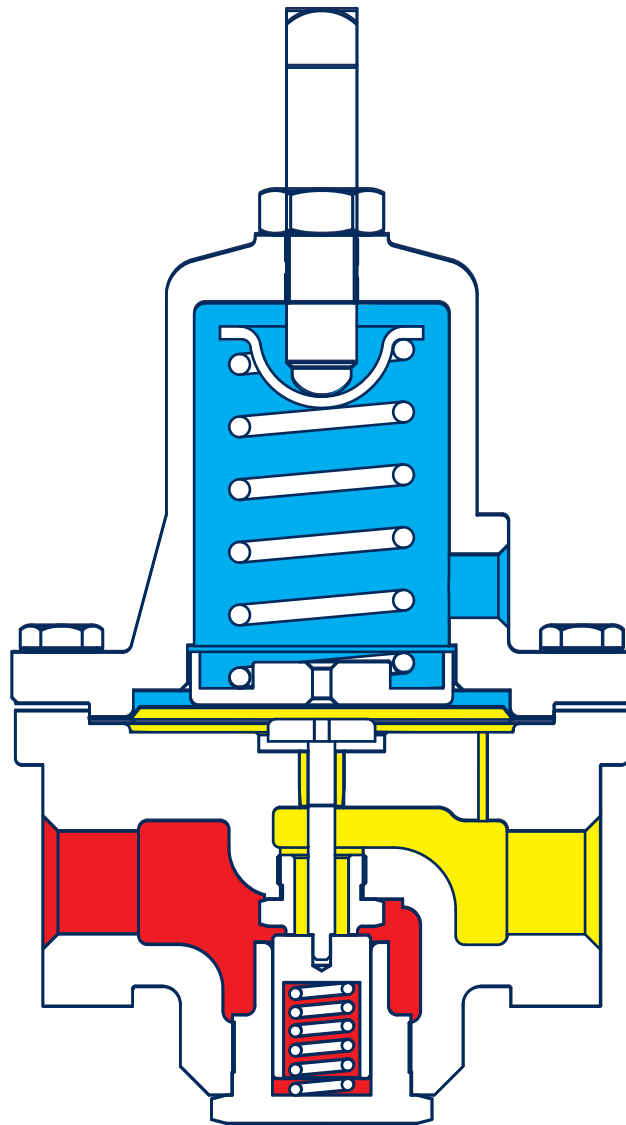

-  Inlet Pressure
-  Outlet Pressure
-  Atmospheric Pressure

P95H 3/4 NPT

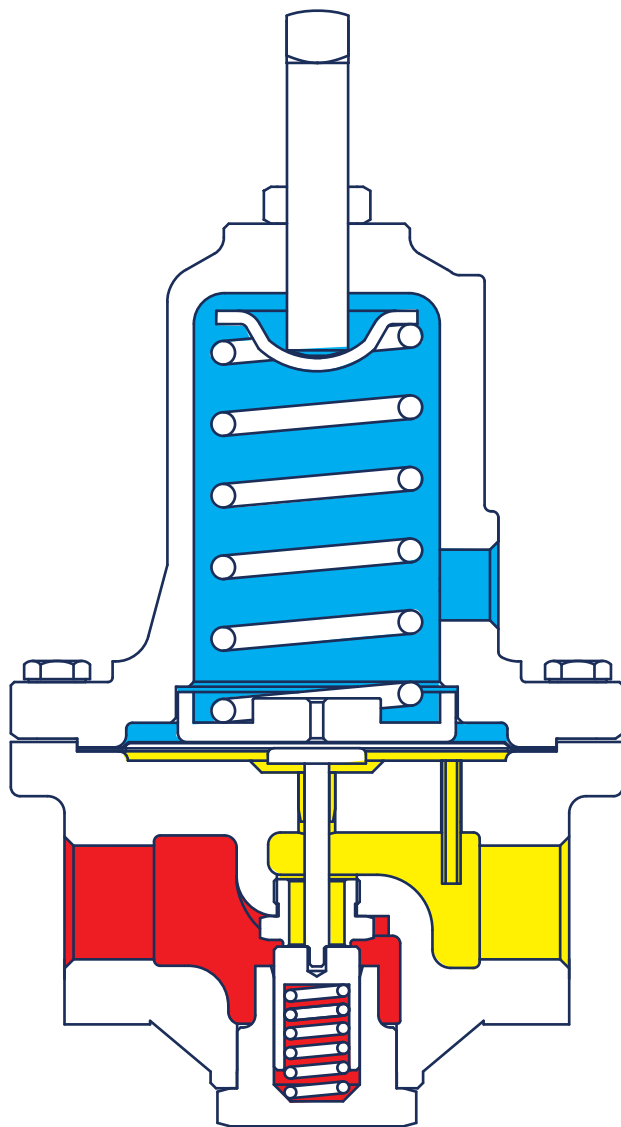

-  Inlet Pressure
-  Outlet Pressure
-  Atmospheric Pressure

P98H

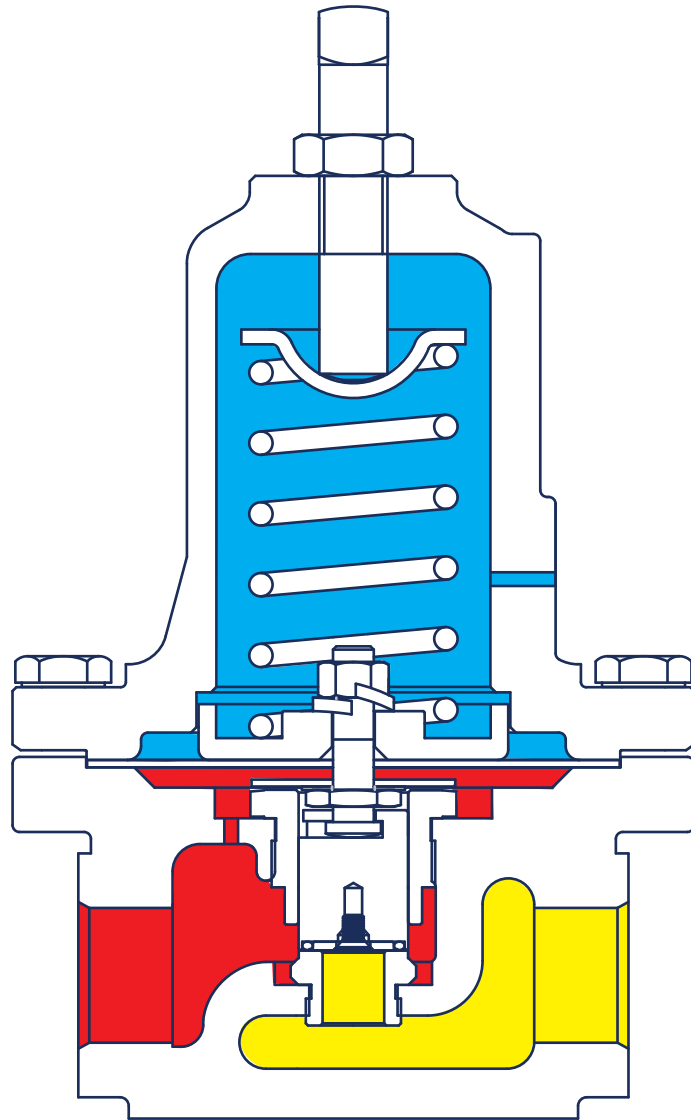

-  Inlet Pressure
-  Exhaust Pressure
-  Atmospheric Pressure

P39

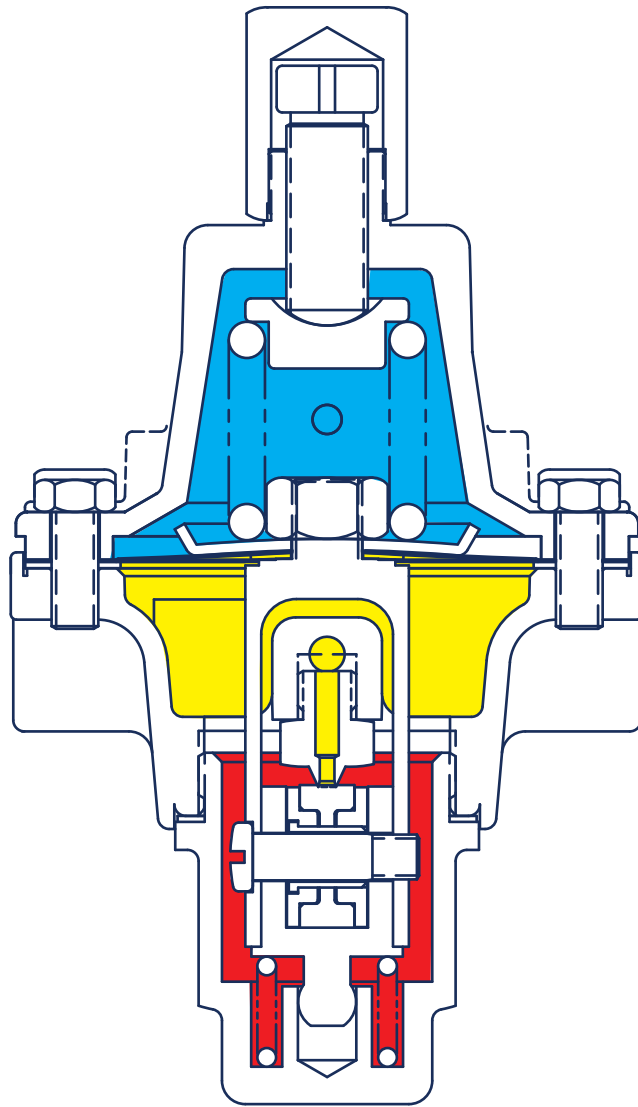

-  Inlet Pressure
-  Outlet Pressure
-  Atmospheric Pressure

P50

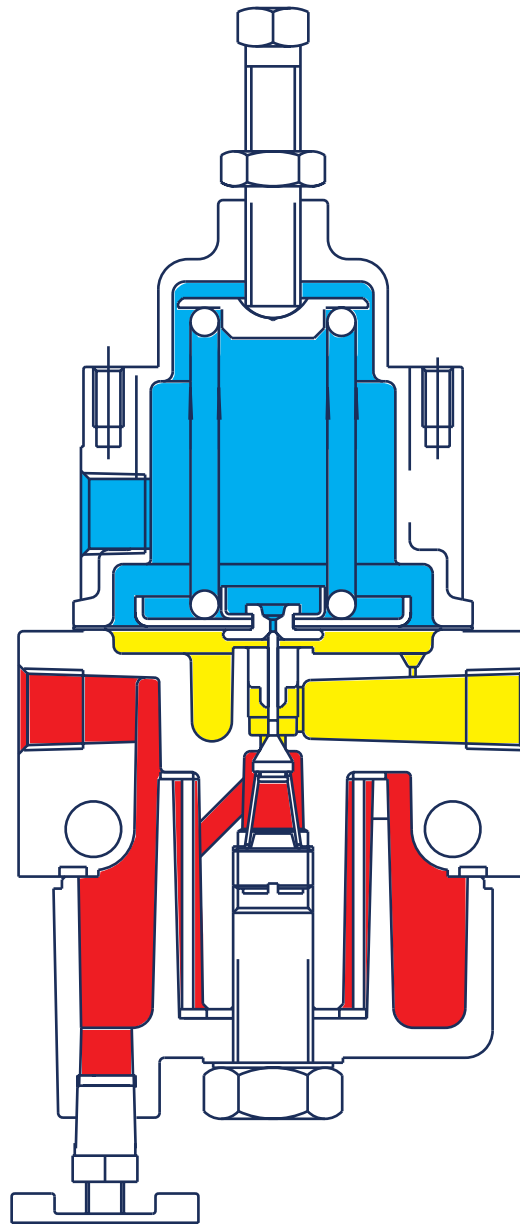

-  Inlet Pressure
-  Outlet Pressure
-  Atmospheric Pressure

P912

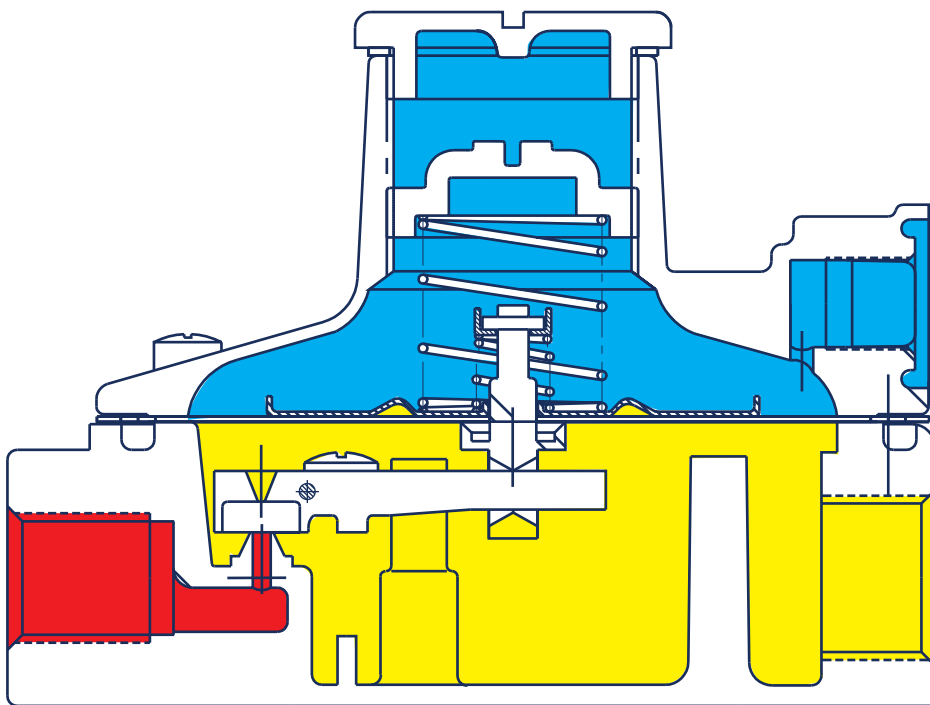

-  Inlet Pressure
-  Outlet Pressure
-  Atmospheric Pressure

P37

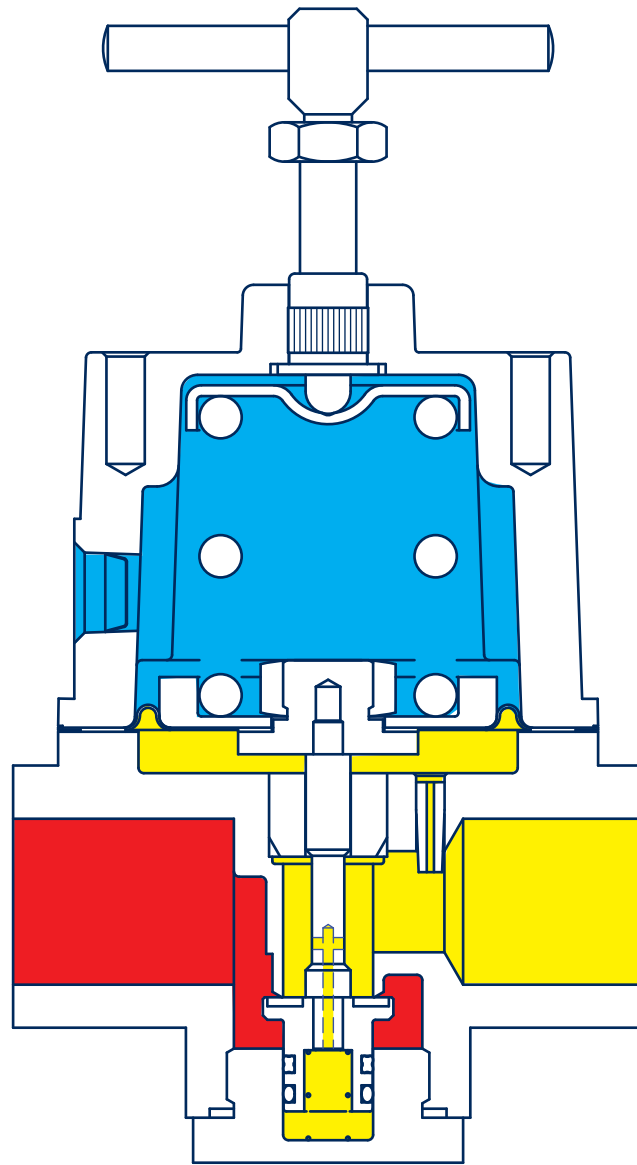

- Inlet Pressure
- Outlet Pressure
- Atmospheric Pressure

P119

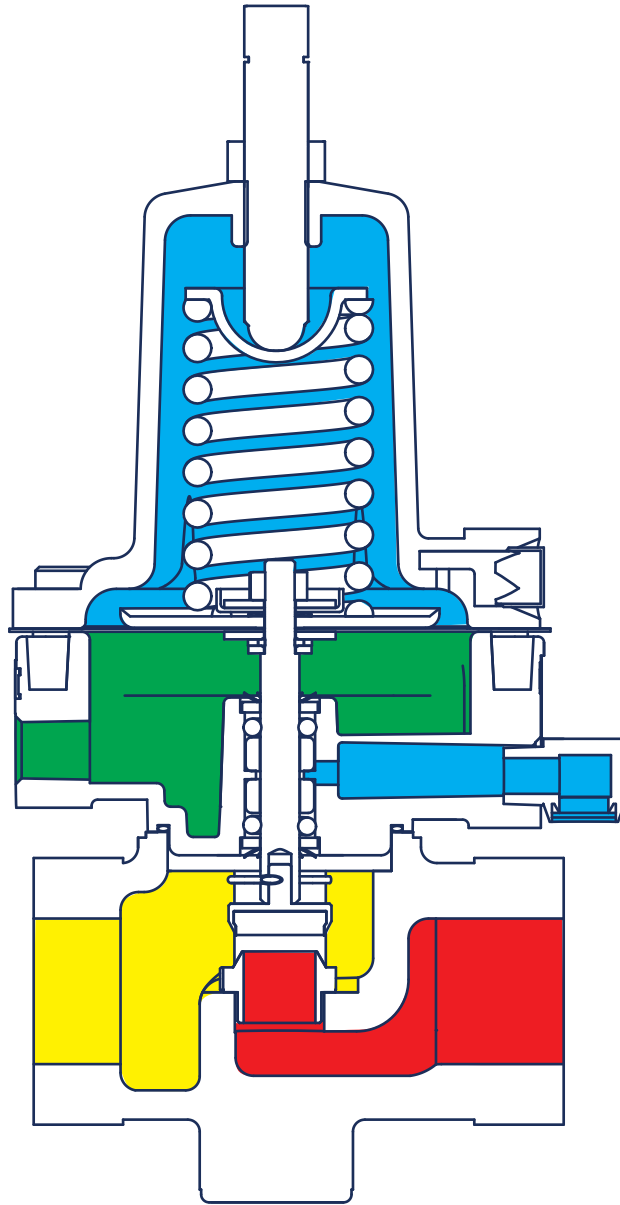

- Inlet Pressure
- Outlet Pressure
- Atmospheric Pressure
- Loading Pressure